



QUATTROVERTER®

25A DC-DC CONVERTER
MODEL: QV24-5-25-1
ADVANCE DATA SHEET

- INPUT: 18 – 36VDC
- OUTPUT: 5VDC @ 25A

FEATURES

- 25A Output Current
- Standard Quarter Brick Package
- Ultra-High Efficiency: 92%
- Fast Transient Response
- Extended Thermal Performance – No Heat Sink Required
- Light Weight – SMT Version Available
- Recovers Automatically from all Protection Modes
- Trim Range: 80 to 110%
- Remote Sense
- Constant Frequency
- Meets Basic Insulation Requirements of EN60950

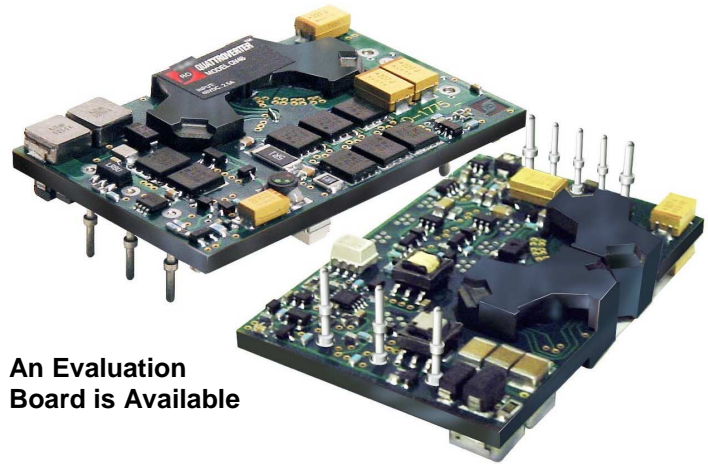

An Evaluation Board is Available

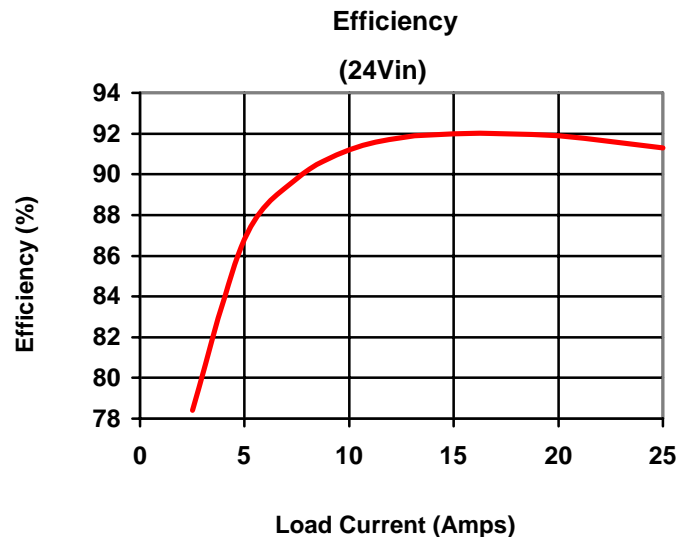

[See Last Page for Available Options](#)

DESCRIPTION

The QUATTROVERTER QV24-5-25-1 is a member of RO's second generation of quarter-brick modules. This improved series of converters pushes the performance envelope to ultra-high levels, with this model producing 25A of 5V power at an astonishing 91% efficiency. The minimal power loss performance is maintained across the load range and is complimented by advanced thermal management and packaging techniques. This combination of performance and packaging makes reliable operation at high currents possible without the use of a heat sink. The QUATTROVERTER family of modules is available in both thru-hole and surface mount versions.

QUATTROVERTER® DC-DC Converters

MODEL: QV24-5-25-1

ABSOLUTE MAXIMUM RATINGS

Exceeding absolute maximum ratings may cause permanent damage and may reduce reliability

PARAMETER	MIN	MAX	UNITS	CONDITIONS
Continuous Input Voltage (+In to -In)	-0.3	36	Vdc	
Transient Input Voltage (+In to -In)	-0.3	40	Vdc	Up to 100ms
On/Off Voltage (On/Off to -In)	-0.3	40	Vdc	
Storage Temperature	-40	+125	°C	
Operating Temperature	-40	+85	°C	Ambient
Soldering Temperature (Wave Solder)		+260	°C	< 5 sec.

SPECIFICATIONS

Specifications apply with 24Vin, full load, 25°C unless indicated otherwise.

INPUT PARAMETERS	MIN	TYP	MAX	UNITS	CONDITIONS
Input Voltage	18	24	36	Vdc	
Startup Voltage	15.5	16	16.5	Vdc	
Shut Down Voltage	14	14.5	15	Vdc	
Maximum Input Current			TBD	A	V _{in} = 18V

OUTPUT PARAMETERS	MIN	TYP	MAX	UNITS	CONDITIONS
Voltage Set Point	4.95	5.00	5.05	Vdc	24V _{in} , Full Load
Load Regulation		5	10	mV	0 A to Full Load, at any V _{in} within range
Line Regulation		5	10	mV	Over V _{in} range
Voltage Drift w/Temperature			0.02	%/°C	-40 to +100 °C
Ripple		75	150	mV p-p	5Hz to 20 MHz, at any V _{in} within range, C _{ext} = 10µF tantalum + 1µF ceramic
Rated Current	0		25	A	
Current Limit Inception	110	120	133	% F.L.	V _{out} = 95% V _{out} nominal
Short Circuit Current			170	% F.L.	V _{out} = 250mV
Transient Response Peak Deviation Settling Time		250 100		mV µsec	Load change from 50% to 75% full load Slew rate = 1A/µsec V _{out} within 1% V _{out} nominal
External Load Capacitance	0		10,000	µF	
Efficiency (See Curve)		92		%	24V _{in} , 3/4 Load

QUATTROVERTER® DC-DC Converters

MODEL: QV24-5-25-1

SPECIFICATIONS (continued)

ISOLATION PARAMETERS	MIN	TYP	MAX	UNITS	CONDITIONS
Input/Output Isolation			1500	Vdc	
Input-to-Output Capacitance		50		pF	
Input-to-Output Resistance	10			M Ohms	

MECHANICAL PARAMETERS	MIN	TYP	MAX	UNITS	CONDITIONS
Weight	35 (1.24)			g (oz.)	
Size	2.3 x 1.45 x 0.42			Inches	

FEATURE PARAMETERS	MIN	TYP	MAX	UNITS	CONDITIONS
Trim Range	4.0		5.5	V	
Over Voltage Protection (Non-Shutdown, Auto. Recovery)	115	120	140	% V_{out} (nom)	OVP threshold does not change when V_o is trimmed
Over Temperature Shut-down (Automatic Recovery)		120		°C	PCB temperature
Turn-On Time		12	20	msec	80% F.L., V_{out} within 1%
Logic On/Off					
Logic Low	0.5			V	$V_{out} = 0$
On/Off Source Current		2		mA	@ $V_{on/off} < 0.5V$
Logic High			15	V	
On/Off Sink Current			50	μA	@ $V_{on/off} = 15V$
Logic Turn-On Time		2		msec	80% F.L., V_{out} settled within 1%

TRIM CIRCUIT CONFIGURATIONS

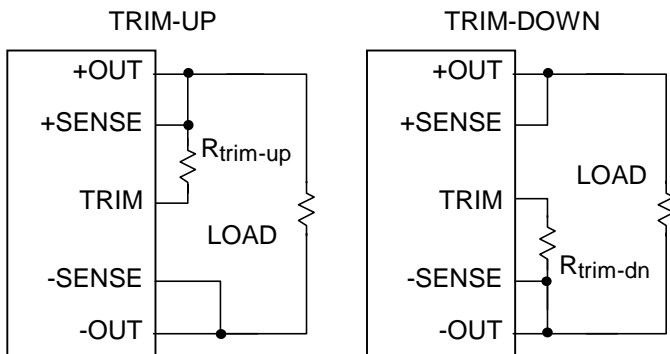

TRIM RESISTOR CALCULATIONS (Standard Trim)

$$R_{trim-up} = \left(\frac{5.11 \cdot V_o \cdot (100 + \Delta\%)}{1.225 \cdot \Delta\%} - \frac{511}{\Delta\%} - 10.2 \right) \cdot k\Omega$$

$$R_{trim-dn} = \left(\frac{511}{\Delta\%} - 10.2 \right) \cdot k\Omega$$

Where:

V_o = The nominal output voltage of the module with no trimming.

$\Delta\%$ = The desired percentage change in the output ($\Delta\%$ is always a positive number).

QUATTROVERTER® DC-DC Converters

MODEL: QV24-5-25-1

Input Characteristics

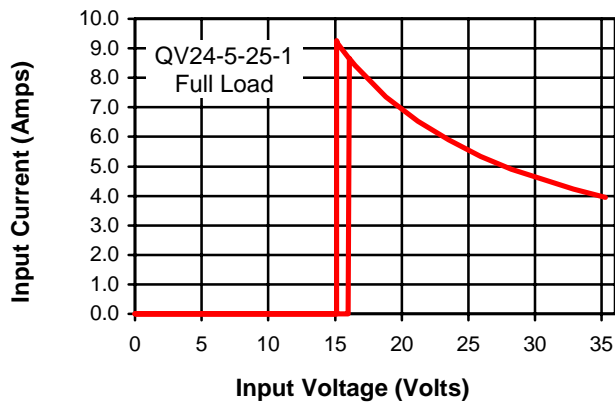

Output Characteristics

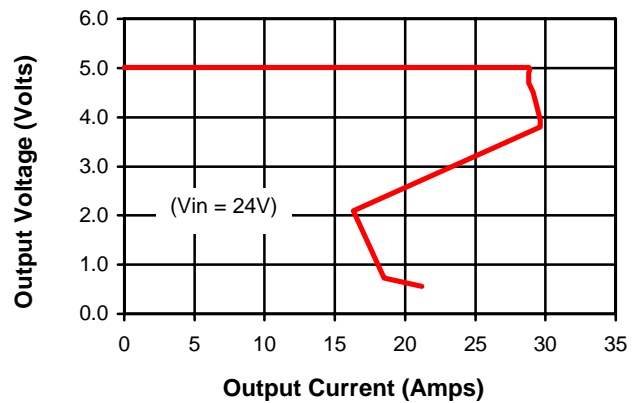

Transient Response

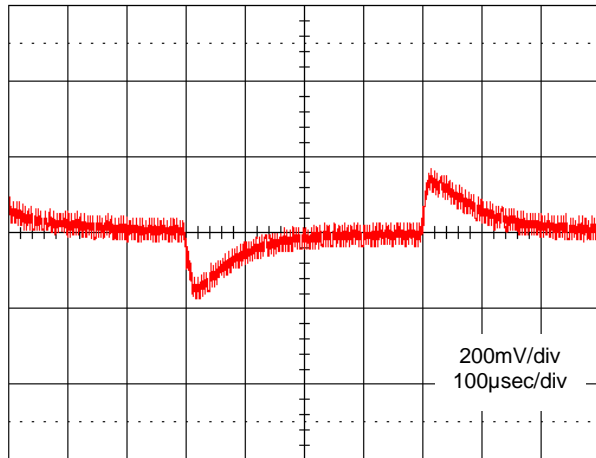

$I_{out} = 12.5A - 18.75A - 12.5A$
Current Slew Rate = 1A/µs

Outline Drawing

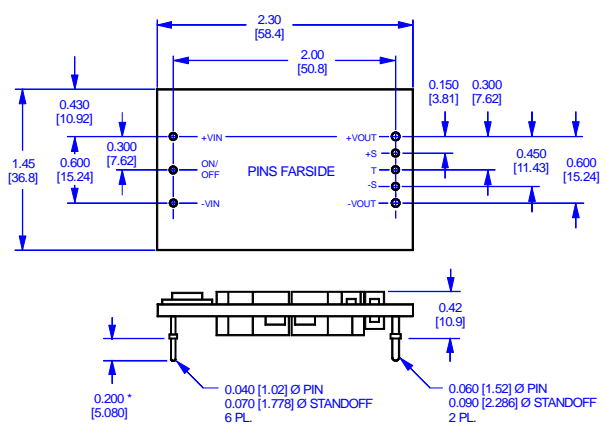

ALL DIMENSIONS ARE IN INCHES (MILLIMETERS)
 TOLERANCES UNLESS SPECIFIED OTHERWISE:
 x.xx in. ± 0.02 in. [x.x mm. ± 0.5 mm.]
 * OTHER PIN LENGTHS AVAILABLE
 x.xxx in. ± 0.010 in. [x.xxx mm. ± 0.25 mm.]

Part Numbering Scheme

Converter Family	V _{in} (nom)	V _{out} (nom)	I _o (rated)	Logic options	Pin options
QV	24	5	25	1	
QuattroVerter Series	24V nom. 18V - 36V	5V output	25A rating	blank = pos. logic 1 = neg. logic (std.)	Blank = 0.200 PTH (std.) 6 = 0.145 PTH 8 = 0.110 PTH SMT = SMT Option

Available Options

Negative Logic – The On/Off pin must be low to turn the module on. If it's left floating, the module turns off. This is the standard logic configuration.

Positive Logic – The On/Off pin must be high to turn the module on. If it's left floating, the module turns on.

Alternate Pin Lengths – In addition to the 0.200" standard thru-hole pins, RO offers 0.145", and 0.110" thru-hole pin lengths.

SMT Mounting – The module is mounted to the target PCB using a surface-mount interface. Contact the factory for further information.

Alternate Trim – Other industry standard trim options are available. Contact the factory for further information.

(minimum quantities and extended lead-times may apply to orders of non-standard options)

RO Associates, Inc.
 P.O. BOX 61419
 Sunnyvale, CA 94088

www.roassoc.com
 rev 030709
 email:sales@roassoc.com

800-443-1450
 408 744-1450
 fax: 408 744-1521